

Quick Guide

OR-T 130



Light application
PP & PET / 9–13 mm



OR-T 260



Universal application
PP & PET / 13–16 mm



OR-T 450



Heavy industry application
PP & PET / 16–19 mm



Package content



Operation



For safety regulations,
refer to operating instructions!

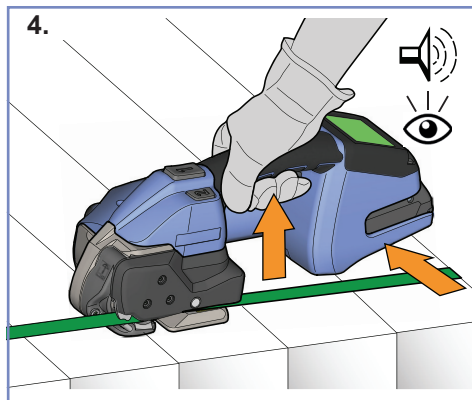
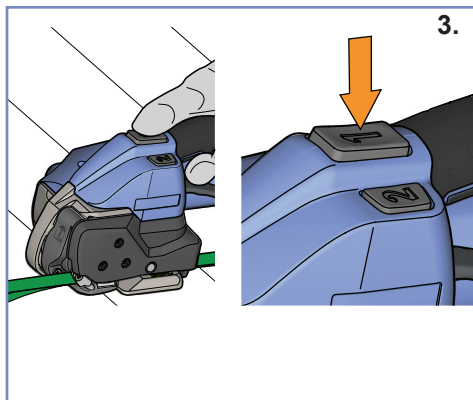
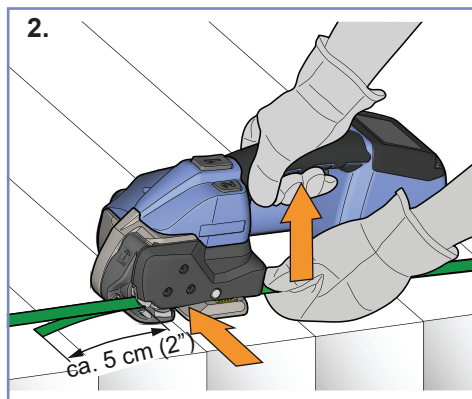
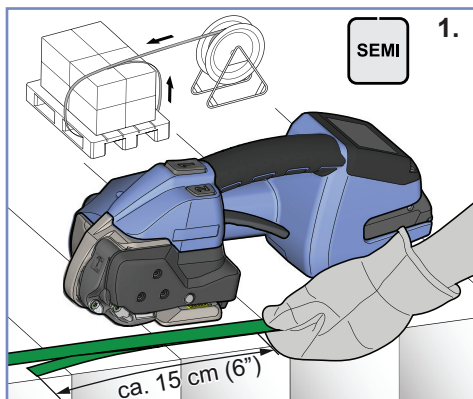

User interface

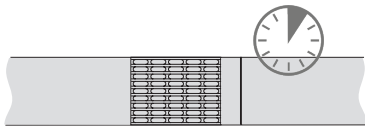
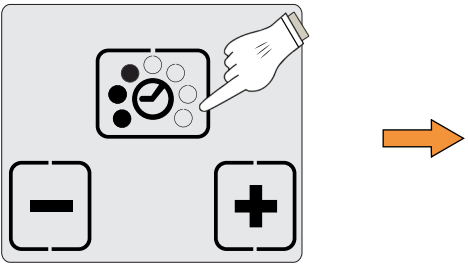
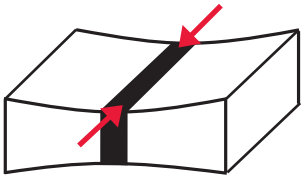
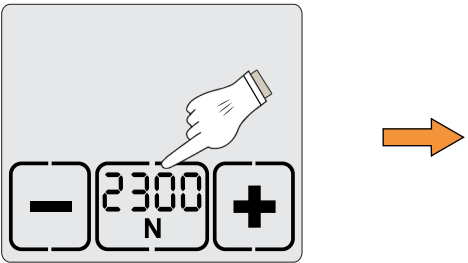
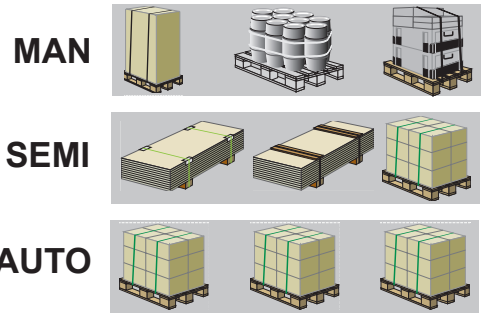
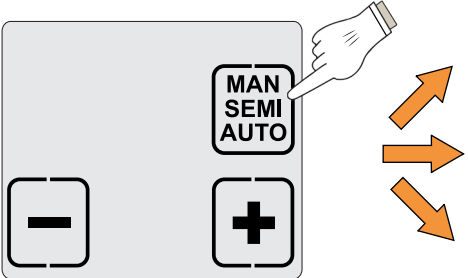
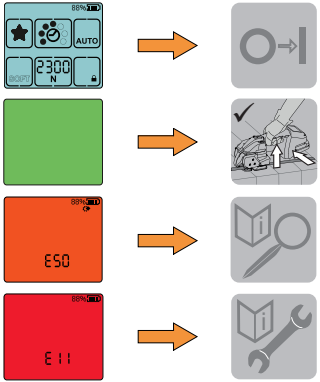
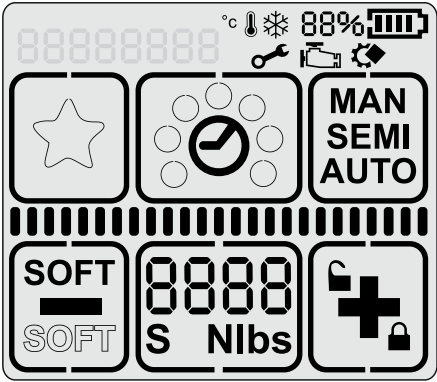

Cleaning/replacing wear parts

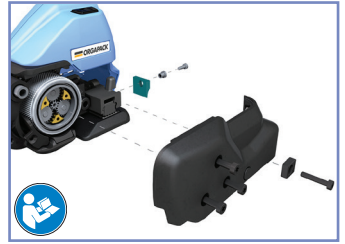

Accessories

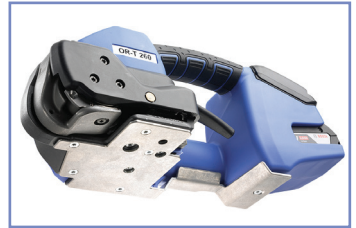

Contact

Orgapack
c/o Signode Industrial Group GmbH
Orgapack Packaging Technology
Silbernstrasse 14
Postfach 595
8953 Dietikon 1, SWITZERLAND
www.sigpse.com



 **ORGAPACK**